



evonicfires

# ELECTRIC FIRES EXCLUSIVELY THROUGH INDEPENDANT FIREPLACE SHOWROOMS

## CONTENTS



Founded in 2005 and based in Stratford upon-Avon, evonicfires occupy a 30,000 sq ft manufacturing facility. Technological advancements and multi-award winning designs make evonicfires one of the leading manufacturers in Europe.

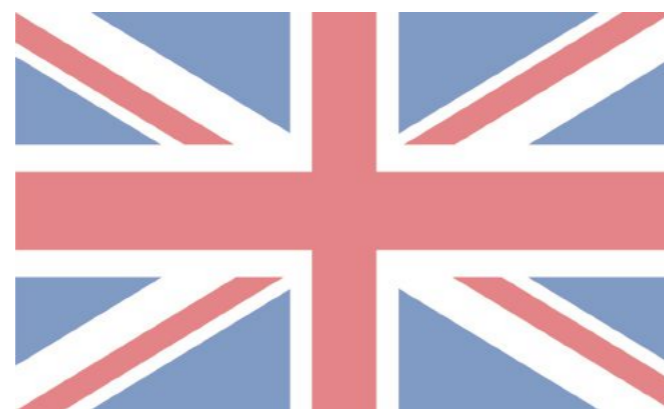

Introduction	4
Benefits of Electric	5
Our Evonic Apps	6
What is Halo?	7
The Range	8
Options	9
Halo	10-21
E-Series	22-49
Traditional	50-61
Stoves	62-67
Suites	68-76
Insets	77-91

**evonicfires** are proud to showcase our innovative new ranges of outstanding electric fires. Adding to our award-winning e-series, suites & inset fires, we have developed a string of unique & exciting products that beautifully pair elegant design with state-of-the-art technology. From our eagerly anticipated Halo models,esteemed e-series range, and a brand new range of traditional electric fires, **evonicfires** can offer a heating solution for every household.



At CK Fires Ltd, our policy is one of constant development and improvement. All products are protected by patents, registered design or intellectual property rights, which will be protected by CK Fires Ltd. All specifications are correct at the time of publishing but are subject to change without notice.

## WHY CHOOSE ELECTRIC?

- Low capital and installation costs
- No combustion, meaning less emissions of harmful particulates, including PM<sub>2.5</sub>
- No need for chimneys or flues
- Countless environmental & health benefits
- Low lifetime costs as there is next to no maintenance
- Reduces your carbon footprint
- No annual safety checks or inspections
- Allows users versatility when choosing a desired location as all you need is a plug
- Complete control over your fire through your smart phone or tablet

# CONTROL FROM YOUR SMARTPHONE OR TABLET

Both Halo and traditional ranges are operated by using the latest IoT technology, our **e-smart** app means you can have complete controllability over your fire.

With a built-in thermostat, adjustable LED brightness and animation settings control, the **e-smart** app allows users to manage every aspect of their appliance simply from their smart phone, tablet or PC.

All suites & e-series, both **evoflame**® and **evoflame ultraHD** are operated by the e-touch app. Features such as temperature control, flame brightness and 7-day programmer are included.



Our **e-smart** App has been designed to give customers seamless control over their Halo or traditional fire.



The e-touch® control system is a fully portable, rechargeable, blue-tooth based touch screen unit, featuring a built-in thermostat, enabling you to regulate and maintain the selected room temperature with ease.

# WHAT IS HALO?

Halo is our latest innovation in flame design. Halo allows complete personalisation of your flame effect, featuring

RGB driven LED technology, allowing limitless animation to feature in your chosen appliance. Simply connect your device to your router and choose one of the 6 pre-selected animations or enjoy creating your own flame effects with a unique spectrum of colour options.

Halo is available in suites or fires throughout our brochure.



You can download the **e-smart** App on Google Play and the Apple App store. Halo fires are fully compatible with Alexa, giving users the ability to control their fire through voice command.



# THE RANGE



Halo, our latest innovation in electric fires, is a new RGB flame effect that comes with pre-set animations - Still / Breathe / Spectrum / Embers / Odyssey / Aurora



Our traditional range of electric fires are perfect for those looking for a high quality product, and are complete with conversion panels to adapt into 2 or 3 sided models (excludes suites).

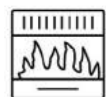

Our inset fires come in various contemporary and traditional designs. They are the perfect addition for both modern and traditional surrounds.



Our award-winning e-series range are a versatile, modern day electric fire with the latest LED lighting technology. These models come in a variety of sizes, and complete with conversion panels to adapt into two or three sided models.



Our range of contemporary electric fire suites bring that added touch of style to your living space.



Our authentic range of electric stoves offer a great alternative to wood-burners. With their realistic flame effect, these models are the ideal focal point of any room.

# OPTIONS

## SILVER BIRCH



For a cool, contemporary look. Our silver birch logs will add style & sophistication to your fire.

## WOODLAND



For the traditionalist, our woodland ceramic log set is guaranteed to give your fire an authentic look.

## QUARTZ & CERAMIC SURROUND OPTIONS

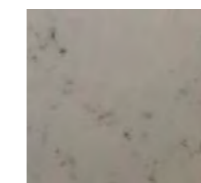

BIANCO TOSCANA

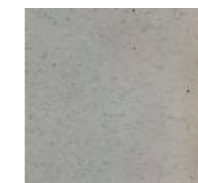

COTTON STAR



ISOLA



LAMINUM PIETRA DE SAVOIA

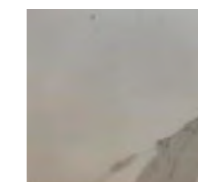

LAMINUM STATUARIO



NIMBUS STAR



NUVALATO

## MDF SUITE OPTIONS

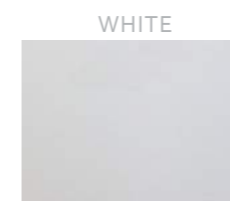

WHITE

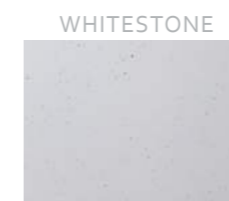

WHITESTONE



BEIGE

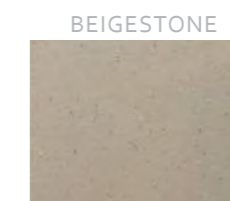











BEIGESTONE



MINERAL GREY

# TYRELL



-  1500 W Heat Output
-  SCHOTT CONTURAN MAGIC® - anti-reflective front glass
-  Woodland or Silver Birch split logs
-  e-smart App controlled
-  Grey or beige ceramic tiles
-  Chrome side Infills
-  Overbed & Tile Wing Illumination
-  Independent fuel bed settings
-  Glass size - H 588mm x W 805mm
-  Appliance size - H 790mm x D 301mm x W 1188mm  
Refer to installation instructions for more detailed specification.



Grey

Beige

# KIRUNA

 1500 W Heat Output

 SCHOTT CONTURAN MAGIC® -  
anti-reflective front glass

 Woodland or Silver Birch split logs

 e-smart App controlled

 Grey or beige ceramic tiles

 Chrome side Infills

 Overbed & Tile Wing Illumination

 Independent fuel bed settings

 Glass size - H 335mm x W 1003mm

 Appliance size -  
H 568mm x D 300mm x W 1420mm  
Refer to installation instructions for  
more detailed specification.



Grey

Beige













halo 

# KALMAR



halo

Shown in Laminum Statuario

-  1500 W Heat Output
-  SCHOTT CONTURAN MAGIC® - anti-reflective front glass
-  Woodland or Silver Birch split logs
-  e-smart App controlled
-  Grey or beige ceramic tiles
-  Chrome side Infills
-  Overbed & Tile Wing Illumination
-  Independent fuel bed settings
-  Available in 7 quartz finishes. See page 9
-  Plinth available in quartz or 5 mdf finishes. See page 9.
-  Appliance size -  
H 609mm x D 350mm x W 1474mm  
Refer to installation instructions for more detailed specification.













Grey

Beige



# LINNEA

-  1500 W Heat Output
-  SCHOTT CONTURAN MAGIC® - anti-reflective front glass
-  Woodland or Silver Birch split logs
-  e-smart App controlled
-  Grey or beige ceramic tiles
-  Chrome side Infills
-  Overbed & Tile Wing Illumination
-  Independent fuel bed settings
-  Glass size - H 335mm x W 1505mm
-  Appliance size - H 556mm x D 300mm x W 1914mm  
Refer to installation instructions for more detailed specification.



Grey

Beige











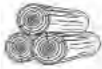

halo 

# LINDSTROM ds



halo

-  1500 W Heat Output
-  SCHOTT CONTURAN MAGIC® - anti-reflective front glass
-  Woodland Ceramic or Silver Birch
-  Two sided Tunnel fire
-  e-smart App controlled
-  Overbed Illumination
-  Independent fuel bed settings
-  Dual sided heater
-  Glass size - H 335mm x W 1002mm
-  Appliance size - H 556mm x D 500mm x W 1002mm  
Refer to installation instructions for more detailed specification.



🔥 Various sizes & heat outputs available

⊕ Horizontal & vertical mounting. Can be affixed to the wall or ceiling.

⊕ Timeless appearance

⊕ Sustainable & energy efficient infrared heating

⊕ Helps reduce carbon footprint & CO2 emissions

⊕ Premium glass fronted models IP44 rated for zone 2 use

⊕ Standard panels include feature lighting system









⊕ IR panels can be used in conjunction with Halo or traditional fires only

⊕ For technical information please see separate brochure

# I.R. Panel



# E1560

-  750/1500 W Heat Outputs
-  SCHOTT CONTURAN MAGIC® - anti-reflective front glass
-  Woodland or Silver Birch
-  e-touch App controlled
-  evoflame ultra HD effect
-  2 or 3 sided conversion panels included
-  Glass size - H 605mm x W 1509mm
-  Appliance size - H 809mm x D 300mm x W 1509mm  
Refer to installation instructions for more detailed specification











evoflame®  
ULTRAHD

GF Model Shown









# E810



-  750/1500W Heat Outputs
-  SCHOTT CONTURAN MAGIC® - anti-reflective front glass
-  Woodland or Silver Birch
-  e-touch App controlled
-  evoflame ultra HD effect
-  2 or 3 sided conversion panels included
-  Glass size - H 1003mm x W 808mm
-  Appliance size -  
H 1209mm x D 316mm x W 808mm  
Refer to installation instructions for more detailed specification

evoflame®  
ULTRAHD

# E1800

-  750/1500 W Heat Outputs
-  SCHOTT CONTURAN MAGIC® - anti-reflective front glass
-  Woodland or Silver Birch
-  e-touch App controlled
-  evoflame ultra HD effect
-  2 or 3 sided conversion panels included
-  Glass size - H 360mm x W 1750mm
-  Appliance size - H 610mm x D 300mm x W 1750mm  
Refer to installation instructions for more detailed specification











evoflame®  
ULTRAHD

GF3 Model Shown









# E1500



-  750/1500W Heat Outputs
-  SCHOTT CONTURAN MAGIC® - anti-reflective front glass
-  Woodland or Silver Birch
-  **evoflame ultra HD** effect
-  **e-touch App** controlled
-  2 or 3 sided conversion panels included
-  Glass size - H 335mm x W 1505mm
-  Appliance size -  
H 556mm x D 300mm x W 1505mm  
Refer to installation instructions for more detailed specification

**evoflame**<sup>®</sup>  
**ULTRAHD**

# E1030

-  750/1500 W Heat Outputs
-  SCHOTT CONTURAN MAGIC® - anti-reflective front glass
-  Woodland or Silver Birch
-  **evoflame ultra HD** effect
-  **e-touch App** controlled
-  2 or 3 sided conversion panels included
-  Glass size - H 335mm x W 1003mm
-  Appliance size -  
H 556mm x D 300mm x W 1003mm  
Refer to installation instructions for more detailed specification



GF Model Shown









**evoflame**<sup>®</sup>  
**ULTRAHD**



# E800











GF3 Model Shown

-  750/1500W Heat Outputs
-  SCHOTT CONTURAN MAGIC® - anti-reflective front glass
-  Woodland or Silver Birch
-  **evoflame ultra HD** effect
-  **e-touch App** controlled
-  2 or 3 sided conversion panels included
-  Glass size - H 590mm x W 800mm
-  Appliance size -  
H 790mm x D 301mm x W 800mm  
Refer to installation instructions for more detailed specification

**evoflame**<sup>®</sup>  
**ULTRAHD**

# E500

-  750/1500W Heat Outputs
-  SCHOTT CONTURAN MAGIC® - anti-reflective front glass
-  Woodland or Silver Birch
-  **evoflame ultra HD** effect
-  **e-touch App** controlled
-  2 or 3 sided conversion panels included
-  Glass size - H 400mm x W 495mm
-  Appliance size - H 610mm x D 301mm x W 495mm  
Refer to installation instructions for more detailed specification









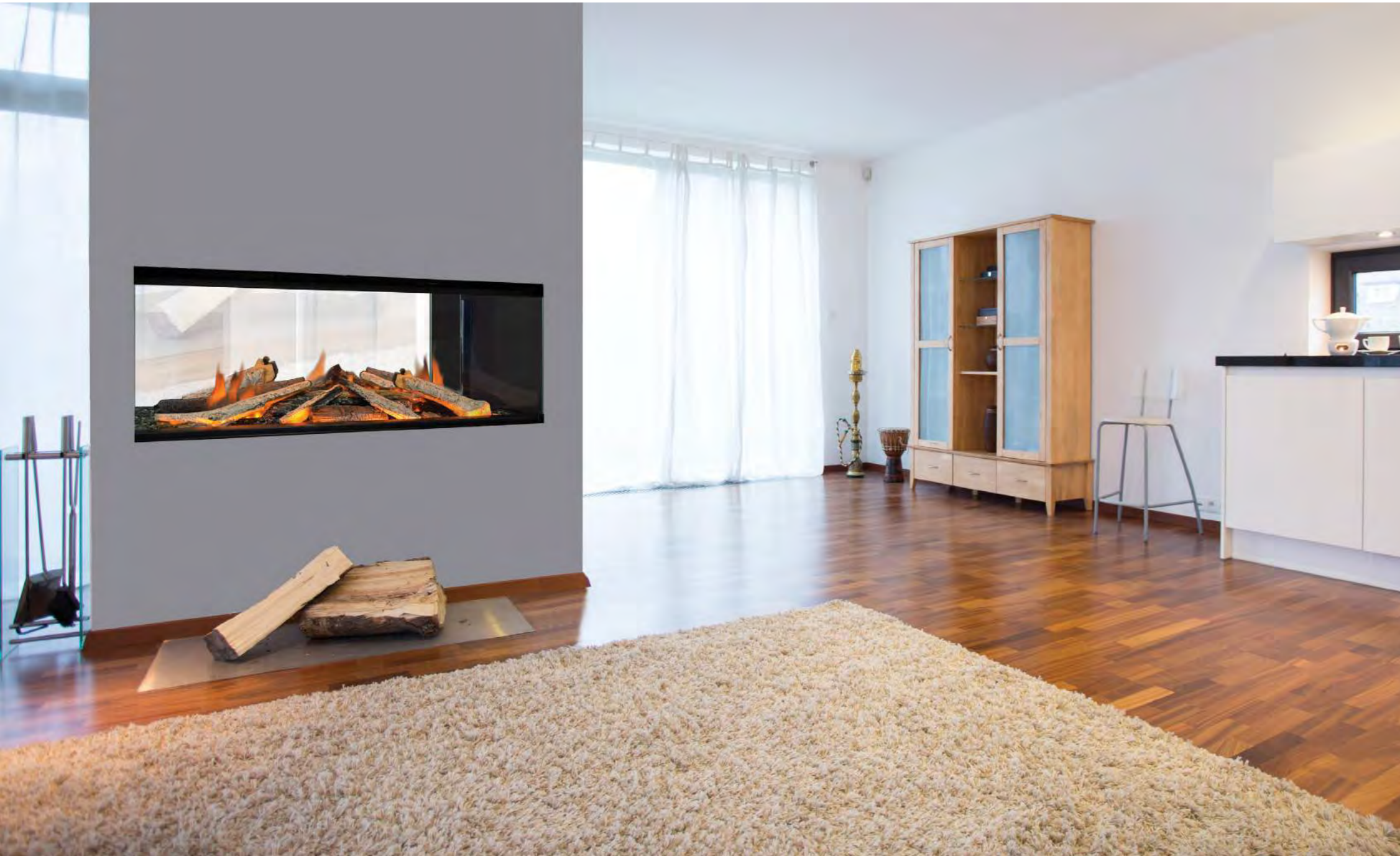

GF3 Model Shown

**evoflame**<sup>®</sup>  
**ULTRAHD**

# E1030ds



-  1500 W Heat Output
-  SCHOTT CONTURAN MAGIC® - Glass fronted
-  Woodland or Silver Birch
-  Two sided Tunnel fire
-  e-touch App controlled
-  Dual sided heater
-  Glass size - H 335mm x W 1002mm
-  Appliance size - H 556mm x D 500mm x W 1002mm  
Refer to installation instructions for more detailed specification

# E1000gf

 750/1500 W Heat Outputs

 Glass fronted

 Woodland or Silver Birch

 **evoflame**® effect

 **e-touch App** controlled

 Also available with Fully Open Fronted Fuel Bed -  
Shown below

 Glass size - H 275mm x W 1002mm

 Appliance size -  
H 475mm x D 180mm x W 1002mm  
Refer to installation instructions for  
more detailed specification



**evoflame**<sup>®</sup>  
technology



# Egoogf



 750/1500W Heat Outputs

 Glass fronted

 Woodland log set

 **evoflame**<sup>®</sup> effect

 **e-touch** App controlled

 Also available with Fully Open Fronted Fuel Bed -  
Shown below

 Glass size - H 491mm x W 884mm

 Appliance size -  
H 695mm x D 196mm x W 884mm  
Refer to installation instructions for  
more detailed specification



**evoflame**<sup>®</sup>  
technology

# E700gf

 750/1500W Heat Outputs

 Glass fronted

 Mini Continental log set

 **evoflame**® effect

 **e-touch App** controlled

 Also available with Fully Open Fronted Fuel Bed and Woodland log set - Shown below

 Glass size - H 285mm x W 640mm

 Appliance size -  
H 480mm x D 200mm x W 640mm  
Refer to installation instructions for more detailed specification



**evoflame**  
technology



# E600gf



 750/1500 W Heat Outputs

 Glass fronted

 Mini Continental log set

 e-touch App controlled

 evoflame® effect

 Also available with fully open fronted fuel bed - Shown below





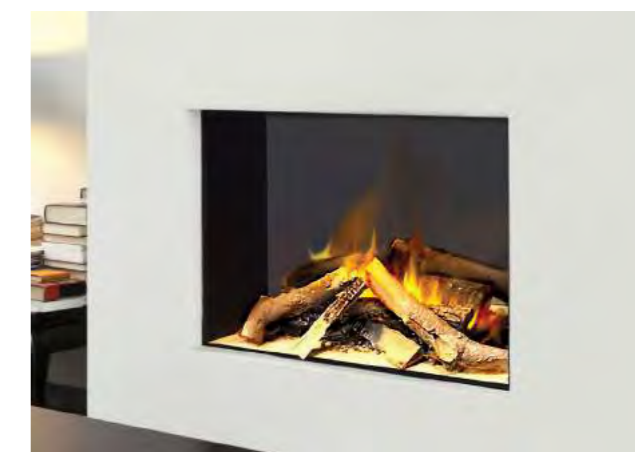

 Glass size - H 455mm x W 637mm

 Appliance size -  
H 638mm x D 180mm x W 637mm  
Refer to installation instructions for more detailed specification



 evoflame®  
Technology

# E710

-  750/1500W Heat Outputs
-  Woodland or Silver Birch
-  **evoflame®** effect
-  **e-touch App** controlled
-  Fully open fronted fuel bed
-  Glass size - H 607mm x W 710mm
-  Appliance size -  
H 790mm x D 200mm x W 710mm  
Refer to installation instructions for  
more detailed specification



**evoflame®**  
technology



# E640gf



 750/1500W Heat Outputs

 Glass fronted

 Woodland log set

 **evoflame**® effect

 **e-touch App** controlled

 Also available with Fully Open Fronted Fuel Bed - Shown below

 Glass size - H 665mm x W 460mm

 H 843mm x D 196mm x W 460mm  
Refer to installation instructions for more detailed specification



**evoflame**®  
technology

# BERGEN

 1500W Heat Output

 Glass fronted

 Woodland or Silver Birch

 e-smart App controlled

 Grey or beige ceramic tiles

 Illuminated tile wings

 Fuel bed illumination - 6 colour variants

 Available in 5 mdf finishes.  
See page 9

 H 609mm x D 353mm x W 1474mm  
Refer to installation instructions for  
more detailed specification.



Grey

Beige











Shown in Beige









# VALTER



3 Sided Model  
Shown with  
Laminum  
pietra de  
savoia plinth

-  1500W Heat Output
-  Glass fronted
-  Woodland or Silver Birch
-  e-smart App controlled
-  2 or 3 sided conversion panels included
-  Fuel bed illumination - 6 colour variants
-  Optional quartz plinth available in 7 finishes. See page 9.
-  Glass size - H 335mm x W 1005mm
-  Appliance size -  
H 568mm x D 300mm x W 1005mm  
Refer to installation instructions for more detailed specification

# NESSA

-  1500W Heat Output
-  Glass fronted
-  Woodland or Silver Birch
-  e-smart App controlled
-  Grey or beige ceramic tiles
-  Illuminated tile wings
-  Fuel bed illumination - 6 colour variants
-  Available in 5 mdf finishes.  
See page 9
-  H 514mm x D 360mm x W 1120mm  
Refer to installation instructions for more detailed specification.



Grey









Beige











Shown in Mineral grey

# KALLAN



-  1500W Heat Output
-  Glass fronted
-  Woodland or Silver Birch
-  e-smart App controlled
-  2 or 3 sided conversion panels included
-  Fuel bed illumination - 6 colour variants
-  Glass size - H 282mm x W 645mm
-  Appliance size -  
H 477mm x D 317mm x W 645mm  
Refer to installation instructions for more detailed specification.

# AAREN

-  1500W Heat Output
-  Glass fronted
-  Woodland or Silver Birch
-  e-smart App controlled
-  Grey or beige ceramic tiles
-  Illuminated tile wings
-  Fuel bed illumination - 6 colour variants
-  Available in 5 mdf finishes.  
See page 9
-  H 688mm x D 363mm x W 845mm  
Refer to installation instructions for  
more detailed specification.



Grey

Beige



# THOREN



2 Sided Model Shown



1500W Heat Output



Glass fronted



Woodland or Silver Birch



e-smart App controlled



2 or 3 sided conversion panels included



Fuel bed illumination - 6 colour variants



Glass size - H 456mm x W 641mm



Appliance size -  
H 640mm x D 316mm x W 641mm  
Refer to installation instructions for  
more detailed specification.



# HALMSTAD

 1500 W Heat Output

 Glass fronted

 Woodland or Silver Birch split logs

 e-smart App controlled

 Independent fuel bed settings

 Available in; Black or white

 H 825mm x D 328mm x W 865mm  
Refer to installation instructions for more detailed specification.











# TUVA



Shown in Black

-  1500 W Heat Output
-  Glass fronted
-  Woodland or Silver Birch split logs
-  e-smart App controlled
-  Independent fuel bed settings
-  Available in; Black or white
-  H 1115mm x D 343mm x W 491mm  
Refer to installation instructions for more detailed specification.



Shown in White



# E V8s

 750/1500 W Heat Outputs

 Floating glass panel

 Silver Birch or Woodland

 Overbed illumination system

 e-touch® App controlled

 evoflame® effect

 Invisible heater

 H 350mm x D 400mm x W 1370mm  
Refer to installation instructions for more detailed specification

# BANFF3

 1000/2000 W Heat Outputs

 Curved door and acrylic side panels

 Woodland or Silver Birch

 evoflame® effect

 Full steel construction

 Available in black

 Optional remote control

 H 671mm x D 355mm x W 460mm  
Refer to installation instructions for more detailed specification

















# NIMBUS

-  750/1500 W Heat Outputs
-  Glass side panels
-  Woodland or Silver Birch
-  e-touch® App controlled
-  evoflame® effect
-  Feature side lighting
-  H 520mm x D 255mm x W 1280mm  
Refer to installation instructions for more detailed specification



White & Oak



Black & Grey Oak











evoflame®  
ULTRAHD



# GALILEO



-  750/1500 W Heat Outputs
-  Available open or glass fronted
-  Woodland log set
-  Altair - evoflame® effect
-  Galileo - evoflame® effect
-  e-touch® App controlled
-  Available in 5 mdf finishes. See page 9
-  Both models available with optional Log Box
-  H 945mm x D 255mm x W 1175mm - Galileo  
H 1135mm x D 255mm x W 1087mm - Altair

# ALTAIR



Refer to installation instructions for more detailed specification



# COMPTON 1000

 750/1500 W Heat Outputs

 Glass side panels

 Woodland or Silver Birch

 Feature side lighting

 **evoflame®** effect

 **e-touch® App** controlled

 Grey or beige ceramic tiles

 Available in 5 mdf finishes. See page 9

 H 520mm x D 365mm x W 1500mm  
Refer to installation instructions for more detailed specification

# COMPTON 2

 750/1500 W Heat Outputs

 Glass side panels

 Woodland or Silver Birch

 Feature side lighting

 **evoflame®** effect

 **e-touch® App** controlled

 Grey or beige ceramic tiles

 Available in 5 mdf finishes. See page 9

 H 520mm x D 365mm x W 1120mm  
Refer to installation instructions for more detailed specification



Shown in White



Shown in White

**evoflame®**  
technology



Grey

Beige



Grey

Beige

**evoflame®**  
technology



# EMPIRE 2

 750/1500 W Heat Outputs

 Glass side panels

 Woodland or Silver Birch

 Feature side lighting

 **evoflame**® effect

 **e-touch**® App controlled

 Grey or beige ceramic tiles

 Available in 5 mdf finishes. See page 9

 H 520mm x D 280mm x W 1120mm  
Refer to installation instructions for more detailed specification

# MIDORI

 750/1500 W Heat Outputs

 **SCHOTT CONTURAN MAGIC**® - anti-reflective front glass

 Woodland or Silver Birch

 **e-touch**® App controlled

 **evoflame ultra HD**® effect

 Colour options; Beige or Black

 H 620mm x D 320mm x W 530mm  
Refer to installation instructions for more detailed specification



**evoflame**®  
technology



Grey

Beige



**evoflame**®  
**ULTRAHD**



# KIBO

 750/1500 W Heat Outputs

 Available open or glass fronted

 Woodland log set

 **evoflame®** effect

 **e-touch® App** controlled

 Available in 5 mdf finishes. See page 9

 H 889mm x D 241mm x W 1258mm  
Refer to installation instructions for more detailed specification



**evoflame®**  
technology



# BROADWAY

 750/1500 W Heat Outputs

 Glass side panels

 Woodland or Silver Birch

 Optional TV unit and legs

 **evoflame®** effect

 **e-touch® App** controlled

 Available in 5 mdf finishes. See page 9









 H 520mm x D 365mm x W 1500mm  
Refer to installation instructions for more detailed specification



**evoflame®**  
technology



# WESTFIELD

-  750/1500 W Heat Outputs
-  Glass side panels
-  Grey or beige ceramic tiles
-  Feature side lighting
-  **evoflame**® effect
-  **e-touch**® App controlled
-  Available in 5 mdf finishes. See page 9
-  H 625mm x D 280mm x W 860mm  
Refer to installation instructions for more detailed specification













Grey

Beige



# BROOKLYN MK 2

-  1000/2000 W Heat Outputs
-  Ceramic log set
-  **evoflame**® effect
-  Front illumination system
-  Fits into 16 x 22 opening
-  Optional stainless steel spacer
-  Overbed illumination system
-  Available in; Polished chrome or satin stainless
-  Optional remote control
-  Frame size - H 605mm x W 490mm x D 130mm  
Refer to installation instructions for













Shown in Chrome



# E V6i













Shown in white

-  750/1500 W Heat Outputs
-  Floating glass panel
-  Woodland or Silver Birch
-  Invisible heater
-  **evoflame®** effect
-  Optional remote control
-  Available in; black or white
-  Chrome frame
-  75mm Deep
-  Fits into 16 x 22 opening
-  Frame size -  
H 625mm x W 590mm - EV6i  
H 655mm x W 590mm - EV6i4

# E V4i



Shown in white

-  750/1500 W Heat Outputs
-  Floating glass panel
-  Woodland or Silver Birch
-  Invisible heater
-  **evoflame®** effect
-  Optional remote control
-  Available in; black or white
-  Chrome frame
-  75mm Deep
-  Fits into 16 x 22 opening
-  Frame size -  
H 590mm x W 480mm - EV4i  
H 620mm x W 480mm - EV4i4

# E V6i4



Shown in black



Side controls



# E V4i4



Shown in black



Side controls





# COLORADO

 750/1500 W Heat Outputs

 Glass fronted

 Ceramic log set

 Side switch controls

 Fits into 16 x 22 opening

 **evoflame®** effect

 Concealed top heater

 Available in; Nickel, chrome, black or brass

 Optional remote control

 75mm Deep

 Frame size - H 605mm x W 460mm  
Refer to installation instructions for more detailed specification



Black



Brass



Chrome



Side controls



# KEPLER 22

 750/1500 W Heat Outputs

 Ceramic log set

 Hot ash fuel bed

 **evoflame®** effect

 Fits into 16 x 22 opening

 Available in; Nickel, chrome, black or brass

 Optional remote control

 75mm Deep

 Frame size - H 605mm x W 645mm  
Refer to installation instructions for more detailed specification



Chrome



Side controls



Shown in Nickel



Shown in Nickel



# MEMPHIS

 750/1500 W Heat Outputs

 Glass fronted

 Ceramic log set

 Cast frame and ashpan

 **evoflame®** effect

 Fits into 16 x 22 opening

 Side switch controls

 Concealed top heater

 Available in; Nickel, chrome or brass

 Optional remote control

 75mm Deep

 Frame size - H 615mm x W 515mm  
Refer to installation instructions for more detailed specification



Shown in Nickel



Chrome



Brass



Nickle



Brass



Side controls



Side controls

**evoflame®**  
technology

**evoflame®**  
technology

# KANSAS

 750/1500 W Heat Outputs

 Ceramic log set

 Side switch controls

 **evoflame®** effect

 Fits into 16 x 22 opening

 Concealed top heater

 Cast frame and ashpan

 Available in; Nickel, chrome or brass

 Optional remote control

 75mm Deep

 Frame size - H 615mm x W 515mm  
Refer to installation instructions for more detailed specification



Shown in Chrome



# IOWA

 750/1500 W Heat Outputs

 Ceramic log set

 Concealed top heater

 **evoflame®** effect

 Fits into 16 x 22 opening

 Side switch controls

 Available in Satin stainless finish

 Optional remote control

 Frame size - H 605mm x W 490mm x D 130mm  
Refer to installation instructions for more detailed specification



Side controls

**evoflame®**  
technology

# DETROIT

 750/1500 W Heat Outputs

 Curved door

 Woodland or Silver Birch

 Hot ash fuel bed

 **evoflame®** effect

 Fits into 16 x 22 opening

 Side switch controls

 Concealed top heater

 Available in; Black or satin stainless

 Optional remote control

 75mm Deep

 Frame size - H 590mm x W 460mm  
Refer to installation instructions for more detailed specification



Black



Side controls

**evoflame®**  
technology



Shown in Satin Stainless



# BROOKLYN

 1000/2000 W Heat Outputs

 Choice of log and fuel effect

 **evoflame®** effect

 Overbed illumination system

 Fits into 16 x 22 opening

 Optional stainless steel spacer

 Available in; Polished chrome or satin stainless

 Optional remote control

 Frame size - H 605mm x W 490mm x D 130mm  
Refer to installation instructions for more detailed specification

# NEBRASKA

 750/1500 W Heat Outputs

 Glass fronted

 Ceramic log set

 Concealed top heater

 Fits into 16 x 22 opening

 **evoflame®** effect

 Side switch controls

 Available in 2 Tone black and brass

 Optional remote control

 75mm Deep

 Frame size - H 605mm x W 495mm  
Refer to installation instructions for more detailed specification



Shown in Polished Chrome



Satin Stainless



Side controls



# TOPAZ

 750/1500 W Heat Outputs

 Ceramic log set

 Fits into 16 x 22 opening

 **evoflame®** effect

 Overbed illumination system

 Available in chrome

 Optional remote control

 75mm Deep

 Frame size - H 605mm x W 645mm  
Refer to installation instructions for more detailed specification

# AMATHUS

 1000/2000 W Heat Outputs

 **evoflame®** effect

 Coal and pebble fuel included

 Fits into 16 x 22 opening

 Available in; Satin stainless, brass, polished chrome or black

 Optional remote control

 75mm Deep

 Frame size - H 602mm x W 506mm  
Refer to installation instructions for more detailed specification



Side controls



Brass



Satin Stainless



Black



Shown with polished Chrome trim & fret



# STATON

 750/1500 W Heat Outputs

 Ceramic log set

 Full satin stainless construction

 **evoflame®** effect

 Fits into 16 x 22 opening

 Side switch controls

 Concealed top heater

 Optional remote control

 75mm Deep

 Frame size - H 615mm x W 505mm  
Refer to installation instructions for more detailed specification

# PHANTOM

 1000/2000 W Heat Outputs

 Log and pebble fuel effect

 **evoflame®** effect

 Fits into 16 x 22 opening

 Available in; Satin chrome, brass or black

 Optional remote control

 75mm Deep

 Frame size - H 602mm x W 505mm  
Refer to installation instructions for more detailed specification



Side controls



Brass



Black



Shown in Satin Chrome



# evonicfires

Evonic House, Clifford Business Park, Clifford Lane,  
Stratford upon-Avon CV37 8HW

TEL: +44(0) 1789 263868 FAX: +44(0) 1789 293080

EMAIL: [sales@evonicfires.co.uk](mailto:sales@evonicfires.co.uk)

[www.evonicfires.co.uk](http://www.evonicfires.co.uk)

 [@evonicfires](https://twitter.com/evonicfires)